

# Prologik Automation – Cobotics Presentation

Palletiser & Depalletiser



# What is a Cobot?

**Collaboration:** Cobots work Alongside your workforce enhancing teamwork.

**Safety:** They prioritise safety, Sensing obstacles to prevent accidents.

**Cost-Efficiency:** Affordable and easy to set up compared to traditional robots.

**Productivity Boost:** They handle repetitive tasks, freeing up humans for more Meaningful work.

**Employee Satisfaction:** The Cobots take on Labour Intensive tasks, improving job employee satisfaction.



# Proposed Solution

**Complete Automation:** Fully automated solution using Cobots to palletise current and future product variations without requiring human intervention.

**Versatile Pallet Sizes:** Cobots handle multiple pallet sizes and can palletise two pallets consecutively before needing personnel attention. This enhances efficiency compared to the current single-pallet process.

**Adaptable Weight Capacity:** The UR10e palletiser accommodates products weighing up to 10 kg. With an additional lift, it can stack products as high as 2200 mm if necessary.

**Enhanced Throughput:** The new solution boasts a capacity of over 15 cases per minute, potentially increasing overall output.

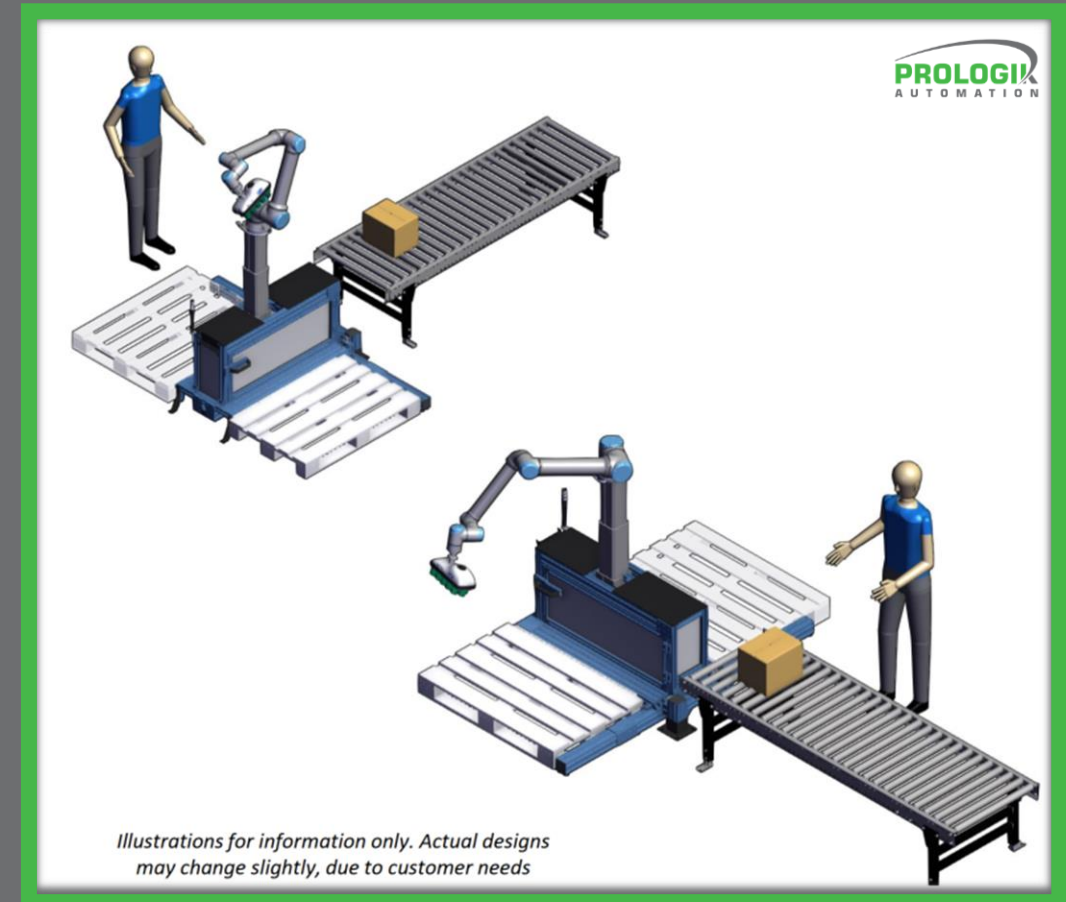

# Proposed Solution

**Diverse Stacking:** Cobots offer flexibility for diverse stack patterns to meet specific needs.

**Fast-Paced Station Transition:** Designed for portability, this palletiser can be swiftly moved to other palletising stations using a pallet truck or forklift.

**Optimised Workforce:** Automating this task frees up your current staff for more complex roles.

**Skills Enhancement:** Introducing user-friendly Cobots provides an opportunity to enhance the skills of your existing workforce.

**Slip Sheet Handling:** Cobots can include slip sheets and dividers on each pallet, streamlining the process.

**Cost-Efficiency:** Potential cost savings and payback can be achieved in under 1.5 years. When transitioning between tasks, payback could be even quicker.



# Transitioning to Profit

If we consider a £77,000 top-of-the-range palletising solution with an included training package, based on a 2-shift rota and a total labour cost of £64,000 per year:

## Unlocking Profitability:

In Year 1, we begin to realise returns setting a course for substantial savings by Year 2.

## Year 2: Rapid Progress:

In Year 2, our journey accelerates. ROI is reached after 1.3 years. Cobot efficiency reduces costs, contributing to a profit of £53,000.00.

## Year 3: Efficiency Maximisation:

Year 3 signifies a phase of optimisation. With consistent Cobot performance, we achieve a ROI of £118,000.00, further underscoring the value of integration.

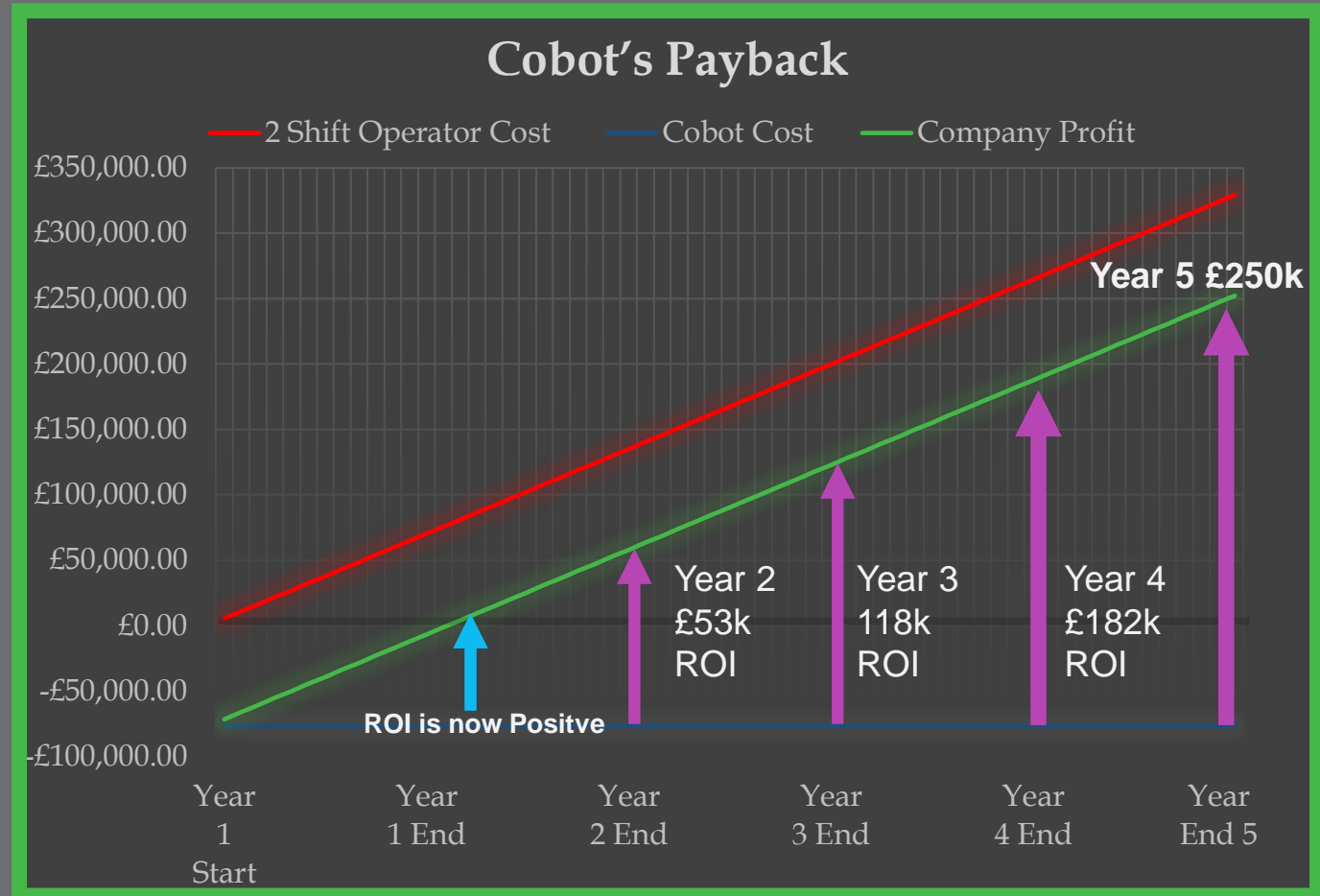

# Your Success Story

## Year 4: Growth and Expansion (2026)

Accelerating growth and substantial profitability.  
Total company profit: £182,000.00.

## Year 5: Sustainability and Success (2027)

Experiencing consistent success with continuous Cobot performance.  
Total company profit: £247,000.00.

## Conclusion:

The company transitions from initial losses to sustained profitability.  
Cobot integration reduces operator costs and enhances efficiency.  
The investment transforms the company's financial performance.

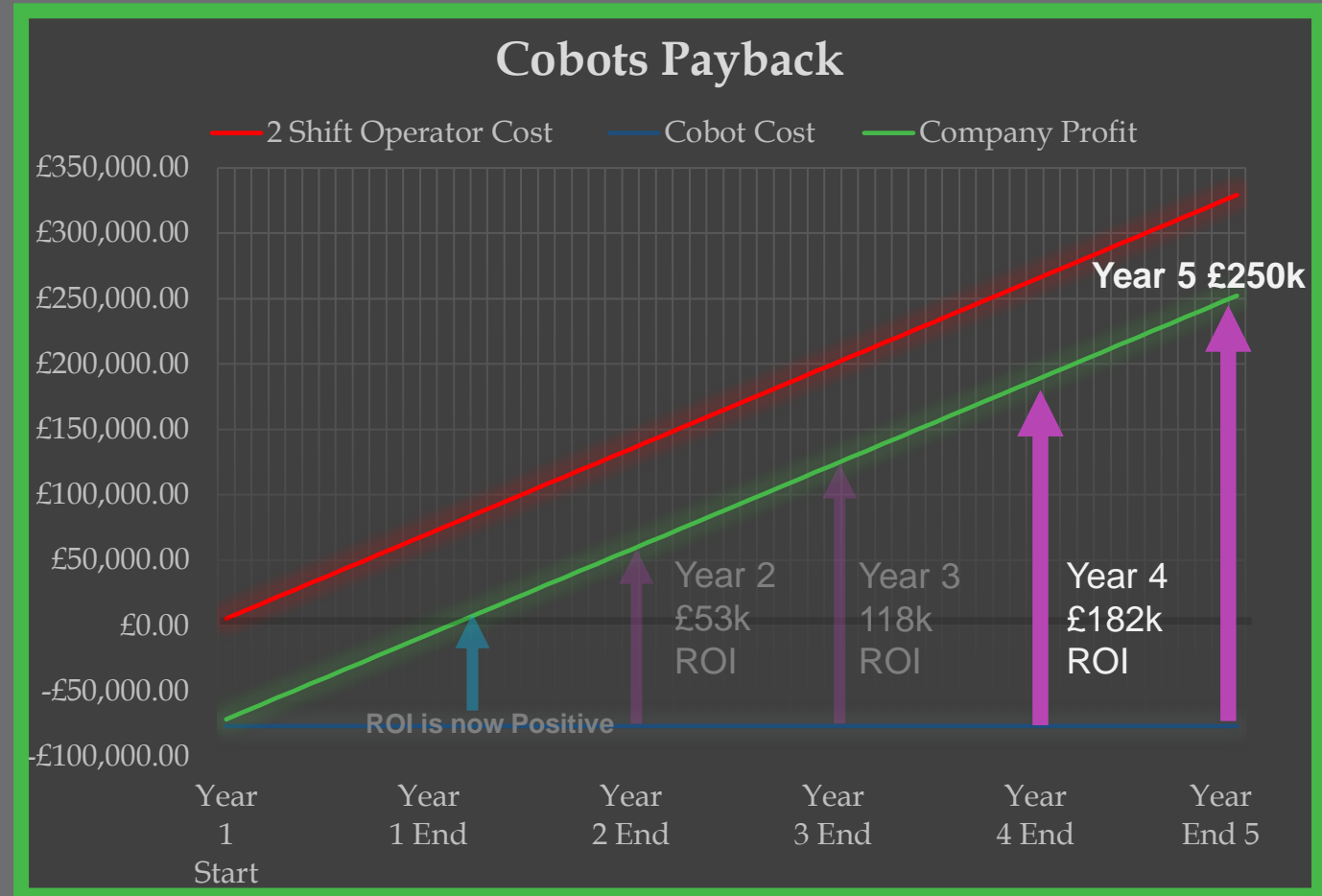

# The Big Win

Comparing this to operator costs over the 5-year period:

For one production line, operator costs can hit £325,000.

Cobots use less power, which saves money on energy and plant operation, ensuring your company not only survives but thrives.

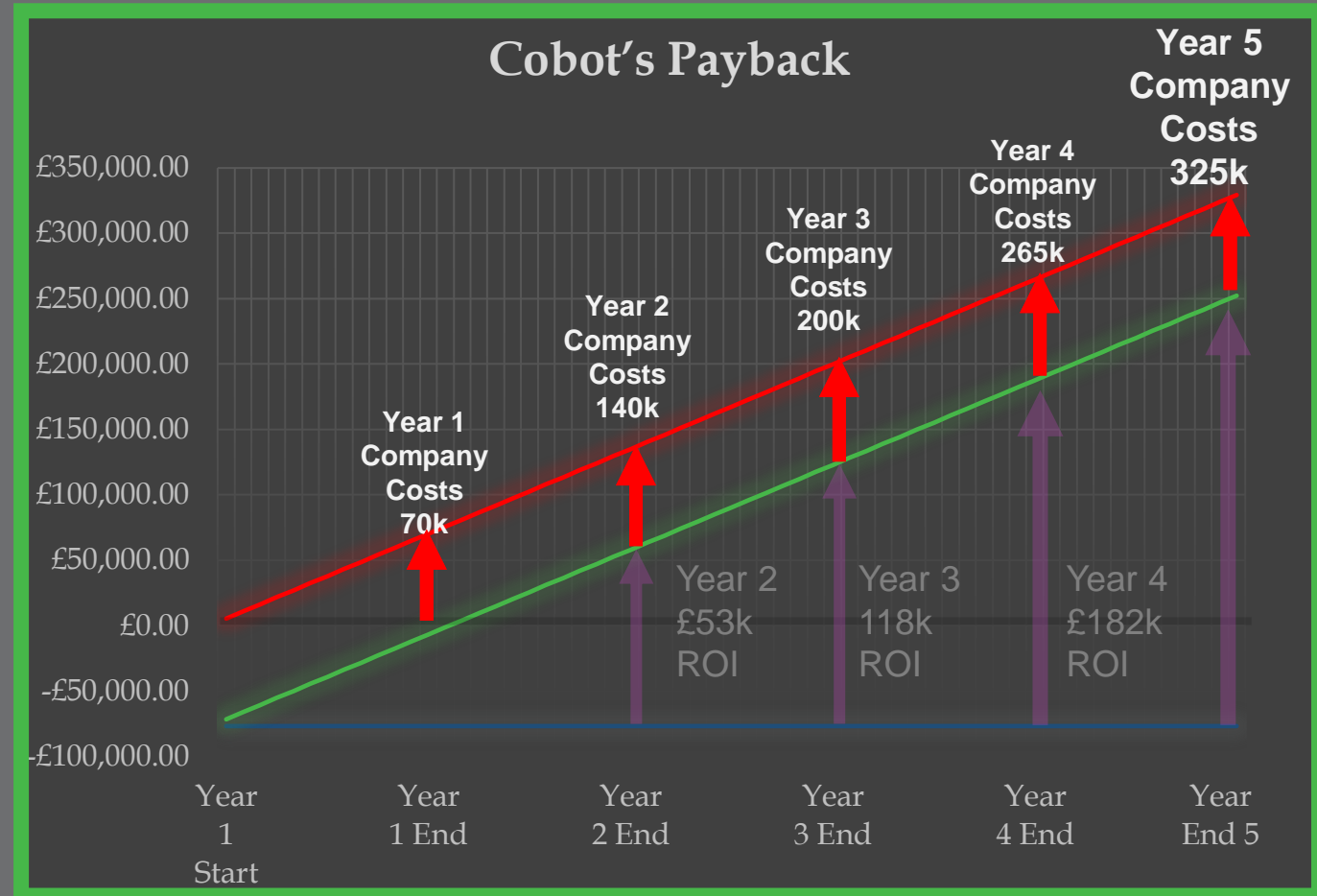

# Please Review Our Figures

**But there's more.**

These numbers reveal a remarkable return on investment over 5 years.

Our solution isn't just about updating your operations; it's about achieving financial success and allowing your staff to take on more meaningful roles.

Please review the numbers for yourself.

	<b>2 shift Operator Cost</b>	<b>Cobot Cost Total</b>	<b>Company Profit</b>
<b>Year 1 Start</b>	<b>£5,400.00</b>	<b>£77,050.84</b>	<b>-£71,650.84</b>
<b>Year 1 End</b>	<b>£70,200.00</b>	<b>£77,050.84</b>	<b>-£6,850.84</b>
<b>Year 2 End</b>	<b>£135,000.00</b>	<b>£77,050.84</b>	<b>£57,949.16</b>
<b>Year 3 End</b>	<b>£199,800.00</b>	<b>£77,050.84</b>	<b>£122,749.16</b>
<b>Year 4 End</b>	<b>£264,600.00</b>	<b>£77,050.84</b>	<b>£187,549.16</b>
<b>Year 5 End</b>	<b>£329,400.00</b>	<b>£77,050.84</b>	<b>£252,349.16</b>



# UR Palletising

Collaborating with our partner, we can offer Universal Robots technology and UR robotics packages.

We bring together off-the-shelf components, training, and application support to introduce UR Palletising

A palletising solution by Prologik Automation and our partner that redefines cost-efficiency, flexibility, safety, and ease of use.

We can also offer UR Safe + UKCA Mark as an optional extra

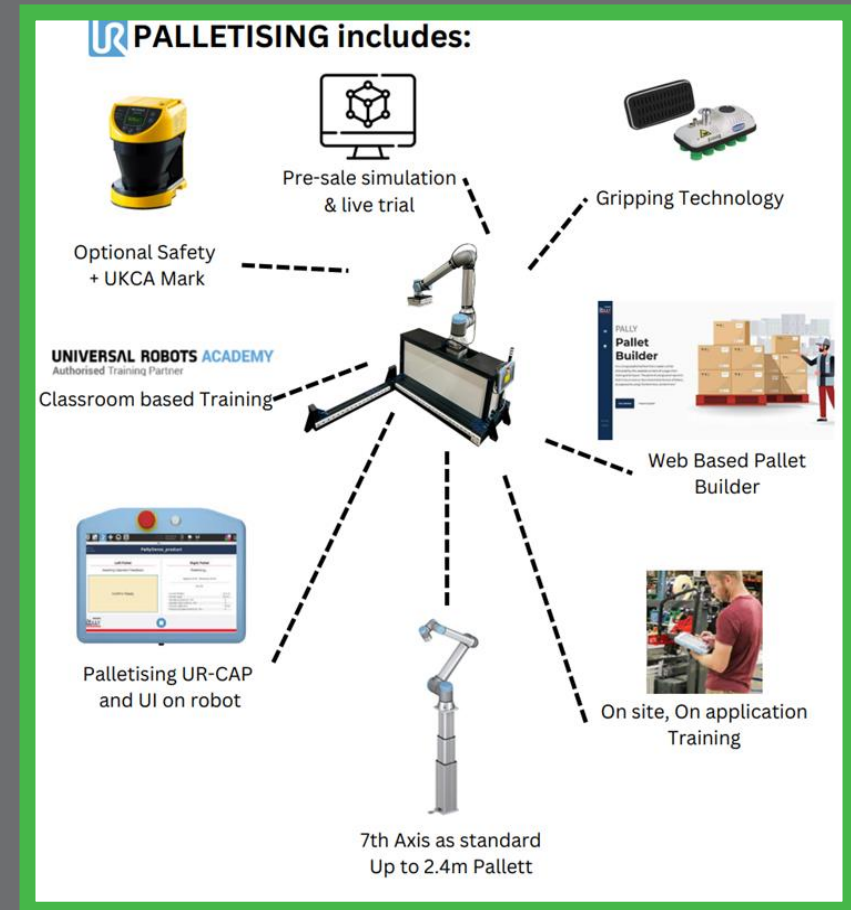

# How the Process Works

To provide you with an idea. This is how the URPALLETISING Process works

5 – 8 Weeks Full Process

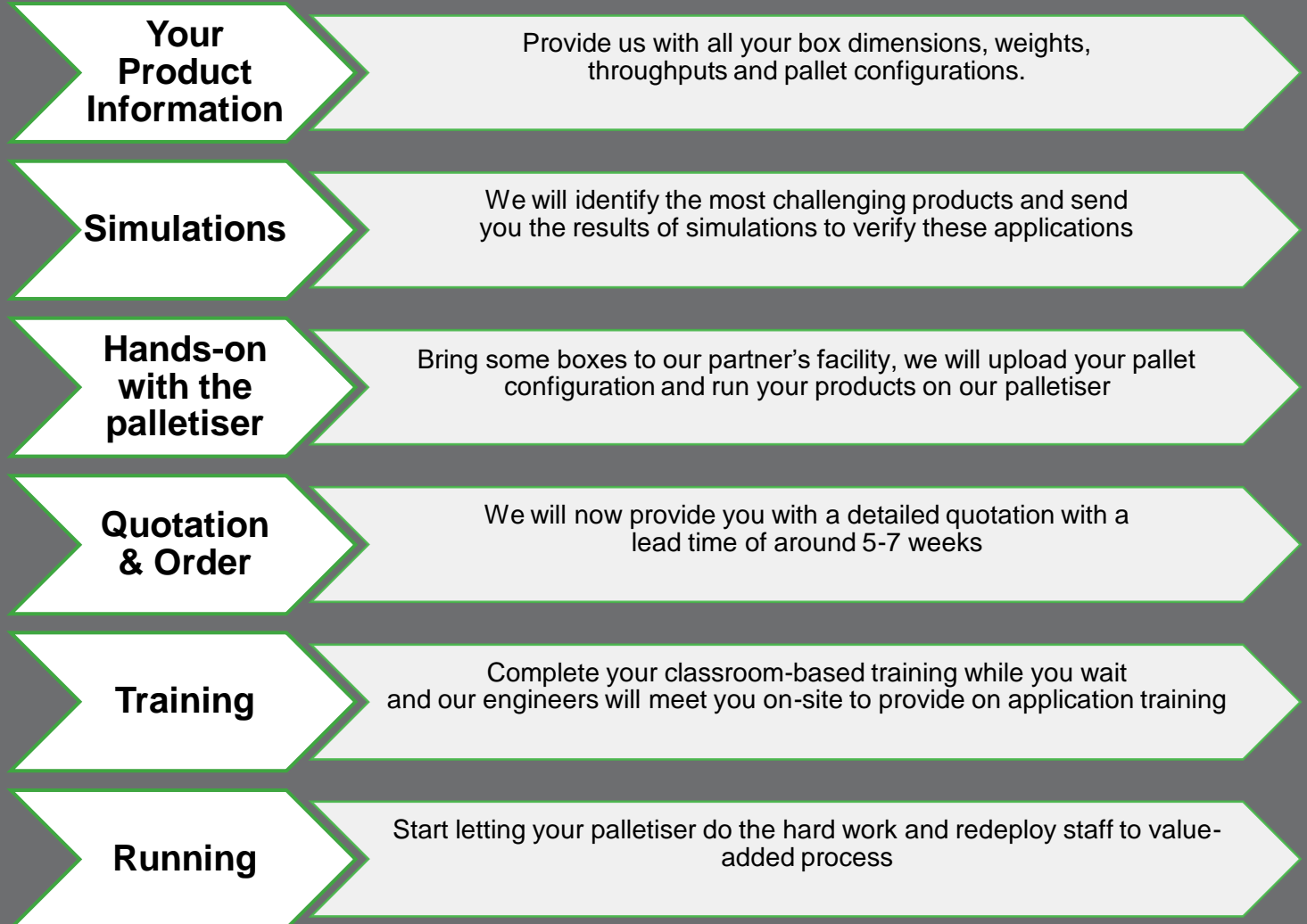

# Safety

**Streamlined Compliance:** URSafe simplifies legal requirements with clear documentation, making risk assessments straightforward and ensuring compliance.

**Space Utilisation:** URSafe employs advanced area scanners, eliminating the need for fixed guarding. This saves space while maintaining high safety standards. The adaptable software suits various setups, enhancing flexibility.

**Comprehensive Safety:** Powered by Keyence Floor Scanners, URSafe offers a 360-degree view of robot activity, ensuring the safety of everyone working alongside Cobots.

**Seamless Integration:** URSafe effortlessly integrates into our standard packages, enhancing your overall experience.

**Personalised Control:** URSafe offers self-deployment, granting you freedom and control over safety on your terms.

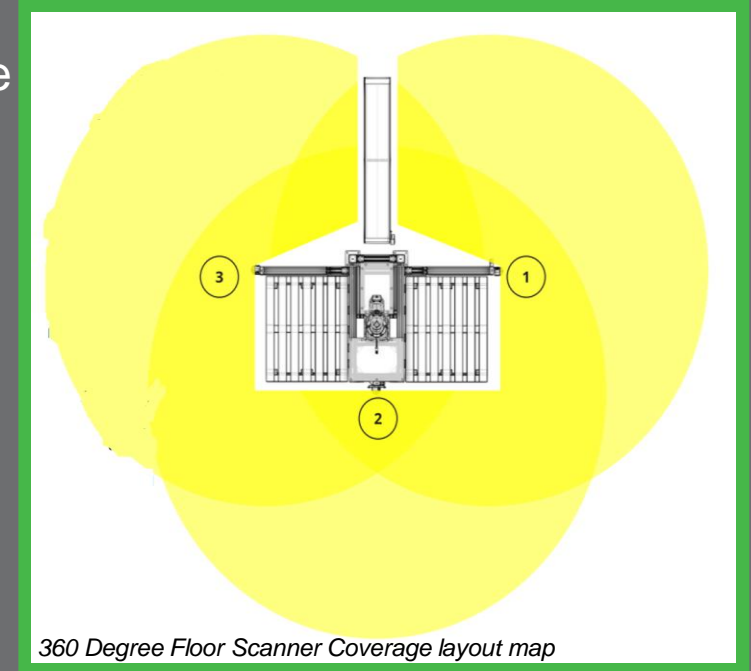

# Enable us to Enable you

Thank you for your time

Embracing these opportunities can lead to substantial returns and contribute to your future success in business

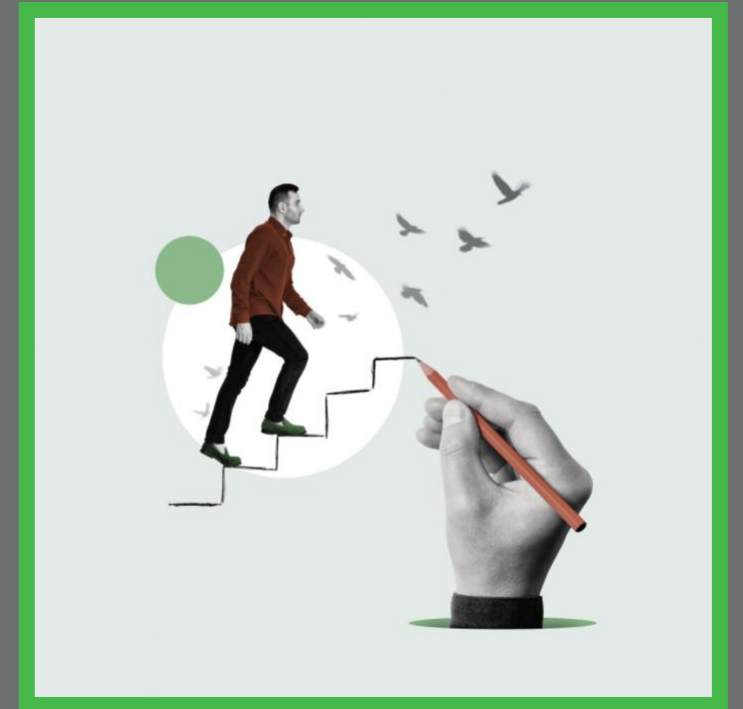

# Contact Us Today



+44 1733 601166

Bakewell Rd, Orton Southgate,  
Peterborough PE2 6XU

[www.pgkpro.com](http://www.pgkpro.com)

[Admin@pgkpro.co.uk](mailto:Admin@pgkpro.co.uk)



*Enabling our customers to be leaders in their markets through automation and digital transformation*

+44 1733 601166  
Bakewell Rd, Orton Southgate,  
Peterborough PE2 6XU  
[www.pgkpro.com](http://www.pgkpro.com)  
[admin@pgkpro.co.uk](mailto:admin@pgkpro.co.uk)

